

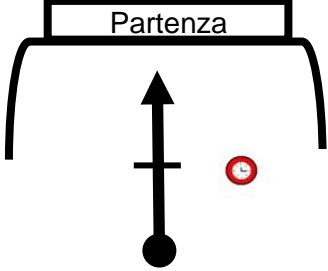









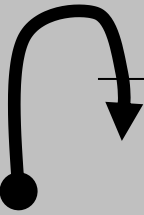
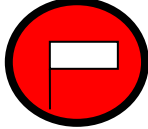

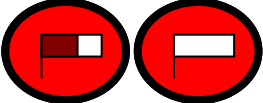
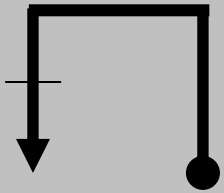
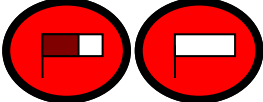

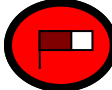
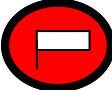

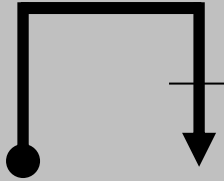
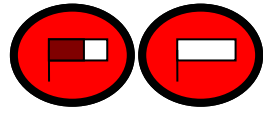

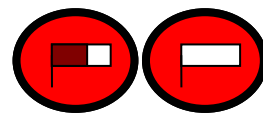
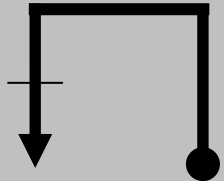
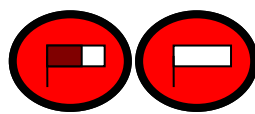

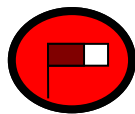
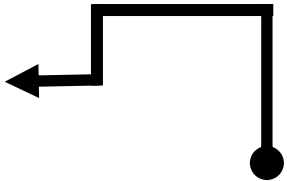
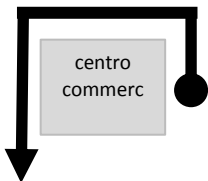
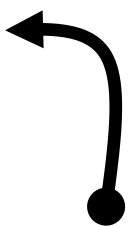

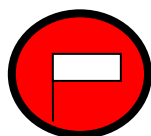
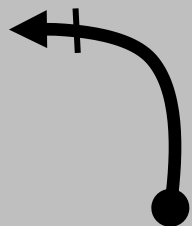
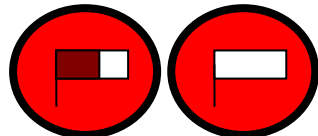

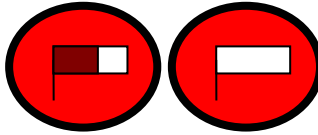
SETTORE			10,570	
1	C.O. 1	MONTEDORO - PARTENZA	0,30	
	C.O. 2	FORINO - STADIO	21,14	
0,000	-		<p>1</p>  <p>C.O 1</p>	10,570
0,020	0,020		<p>2</p>  <p>Start P.C. 1</p>	10,550
0,060	0,040		<p>3</p>  <p>Fine P.C. 1 - Start P.C.2</p>	10,510
0,110	0,050		<p>4</p>  <p>Fine P.C. 2 - Start P.C.3</p>	10,460
0,150	0,040		<p>5</p>    <p>PROSSIMA NOTA A MENO DI 200 MT</p> <p>Fine P.C. 3 - Start P.C.4</p>	10,420

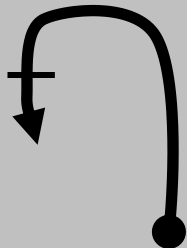
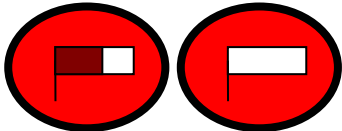
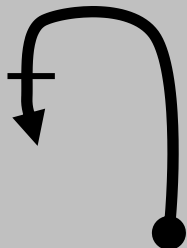
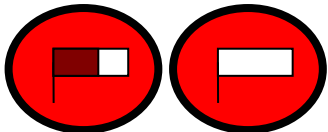
SETTORE			10,570		
1	C.O. 1	MONTEDORO - PARTENZA		0,30	
	C.O. 2	FORINO - STADIO		21,14	
0,200	0,050		6	 Fine P.C. 4 - Start P.C. 5	10,370
0,240	0,040		7	 Fine P.C. 5 - Start P.C.6	10,330
0,290	0,050		8	 Fine P.C. 6 - Start P.C.7	10,280
0,330	0,040		9	 Fine P.C.7	10,240
0,430	0,100		10		10,140

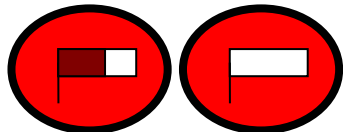
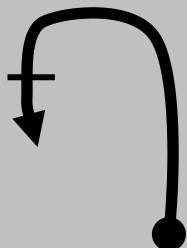
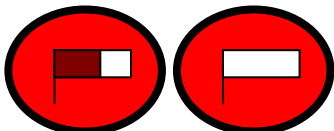

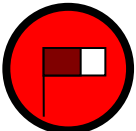

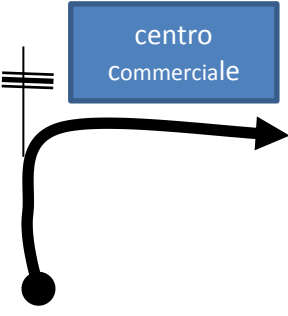
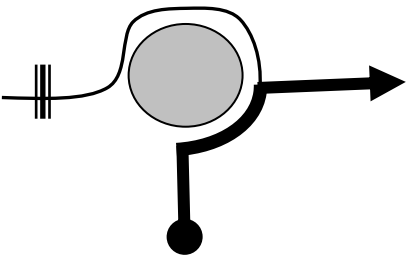
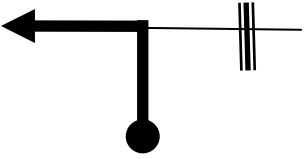
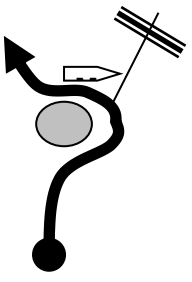
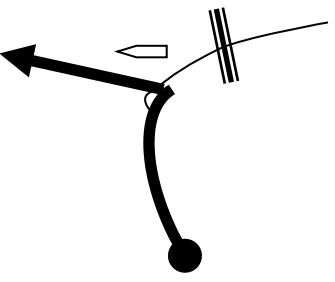

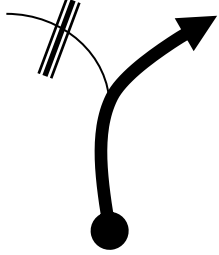
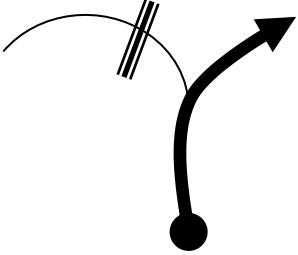
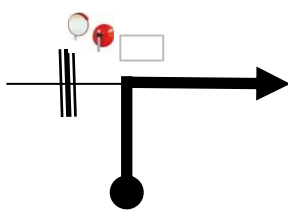
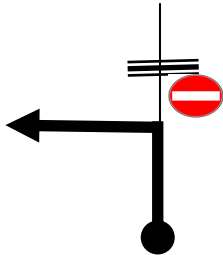
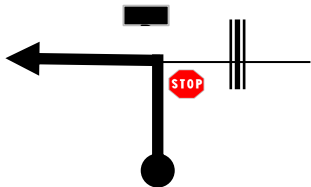
SETTORE			10,570		
1	C.O. 1	MONTEDORO - PARTENZA		0,30	
	C.O. 2	FORINO - STADIO		21,14	
0,680	0,250		<div style="border: 1px solid gray; padding: 5px; margin-bottom: 5px;">           centro commerciale            montedoro         </div> <div style="border: 1px solid gray; padding: 5px;">           !!! procedere a passo d'uomo            !!! possibile incrocio con altri concorrenti         </div>	11	9,890
0,730	0,050			12	9,840
0,750	0,020			13	9,820
0,780	0,030			14	9,790
0,810	0,030			15	9,760
			 PROSSIMA NOTA A MENO DI 200 MT		





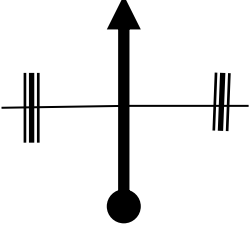
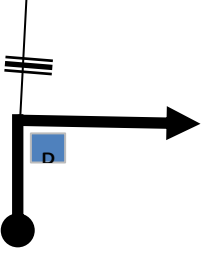

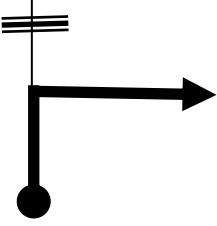
SETTORE			10,570	
1	C.O. 1	MONTEDORO - PARTENZA		0,30
	C.O. 2	FORINO - STADIO		21,14
0,860	0,050		16	 Fine P.C. 10 Start P.C. 11 9,710
0,910	0,050		17	 Fine P.C. 11 - Start P.C. 12 9,660
0,940	0,030		18	 Fine P.C. 12 - Start P.C. 13 9,630
0,990	0,050		19	 Fine P.C. 13 - Start P.C. 14 9,580
1,020	0,030		20	  PROSSIMA NOTA A MENO DI 200 MT Fine P.C. 14 9,550

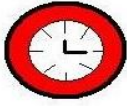
SETTORE				10,570	
1	C.O. 1	MONTEDORO - PARTENZA		0,30	
	C.O. 2	FORINO - STADIO		21,14	
1,190	0,170		21	<div style="border: 1px solid black; padding: 5px; text-align: center;">!!! attenzione procedere a passo d'uomo</div>	9,380
1,260	0,070		22	<div style="border: 1px solid black; padding: 5px; text-align: center;">!!! procedere a passo d'uomo siete nel parcheggio di un centro commerciale</div>	9,310
1,290	0,030		23	IMMISSIONE SU STRADA STATALE	9,280
2,040	0,750		24	<div style="border: 1px solid black; padding: 5px; text-align: center;"><del>MONTEFORTE I.</del></div>	8,530
2,640	0,600		25	<div style="border: 1px solid black; padding: 5px; text-align: center;">autocarrozzeria</div>	7,930

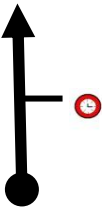
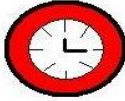
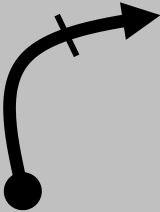
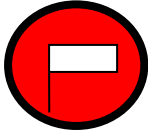

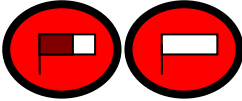
SETTORE				10,570
1	C.O. 1	MONTEDORO - PARTENZA		0,30
	C.O. 2	FORINO - STADIO		21,14
5,540	2,900		26	5,030
8,240	2,700		27	2,330
9,040	0,800		28	1,530
9,190	0,150		29	1,380
9,590	0,400		30	0,980

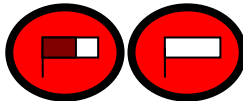
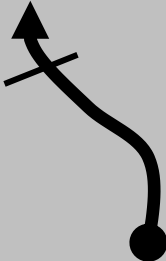
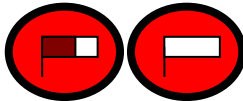





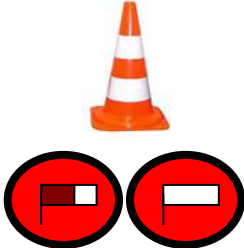
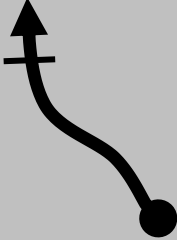
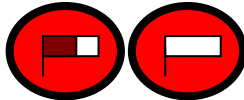

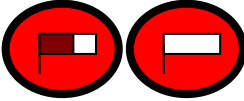
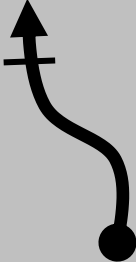
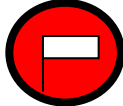
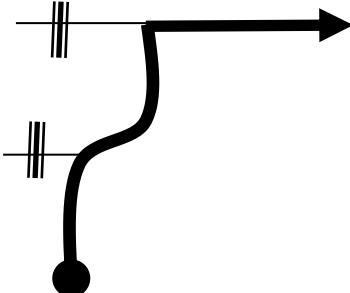

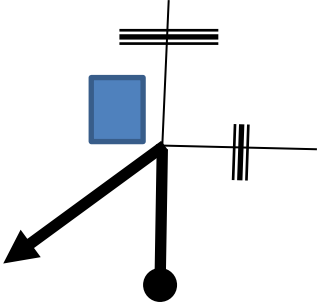
SETTORE				10,570	
1	C.O. 1	MONTEDORO - PARTENZA		0,30	
	C.O. 2	FORINO - STADIO		21,14	
9,640	0,050		31	  <p>Caffetteria - Gelateria (Pausa Caffè)</p>	0,930
9,690	0,050		32		0,880
10,490	0,800		33		0,080
10,540	0,050		34		0,030
10,570	0,030		35	 C.O 2	0,000

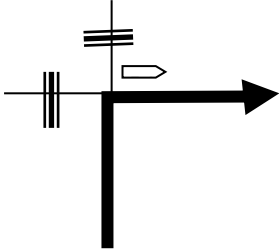
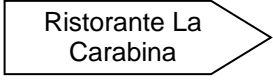
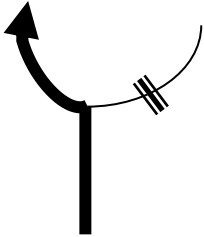

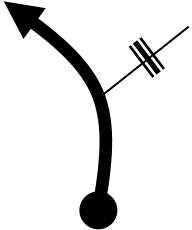
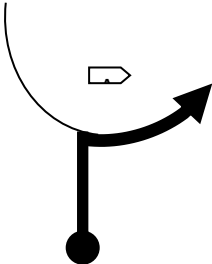



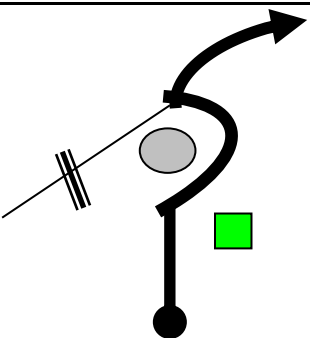
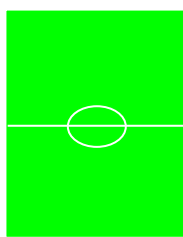
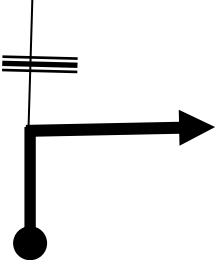
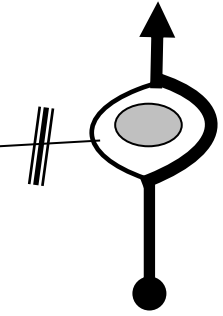

SETTORE				9,280	
2	C.O. 2	FORINO - STADIO		0.20	
	C.O. 3	MONTEDORO		27,84	
0,000	-		1	 C.O. 2	9,280
0,050	0,050		2	 Start P.C. 15	9,230
0,100	0,050		3	 Fine P.C. 15 - Start P.C. 16	9,180
0,140	0,040		4	 Fine P.C. 16 - Start P.C. 17	9,140
0,175	0,035		5	  PROSSIMA NOTA A MENO DI 200 MT Fine P.C. 17 - Start P.C. 18	9,105

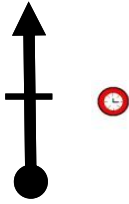

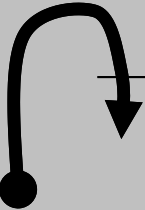
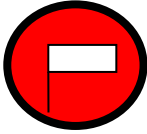

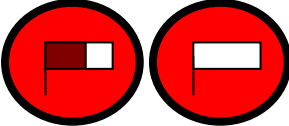
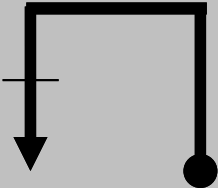
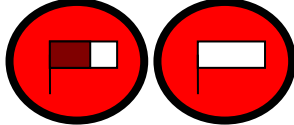

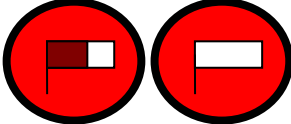

SETTORE				9,280	
2	C.O. 2	FORINO - STADIO		0.20	
	C.O. 3	MONTEDORO		27,84	
0,225	0,050		6	 Fine P.C. 18 - Start P.C. 19	9,055
0,260	0,035		7	 Fine P.C. 19 Start P.C. 20	9,020
0,300	0,040		8	 Fine P.C. 20 - Start P.C. 21	8,980
0,350	0,050		9	 Fine P.C. 21	8,930
0,450	0,100		10	!!! IMMISSIONE SU S.P.	8,830



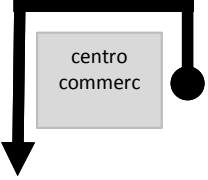

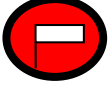
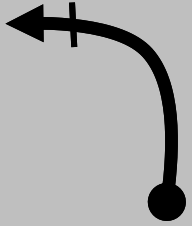
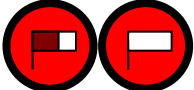
SETTORE				9,280	
2	C.O. 2	FORINO - STADIO		0.20	
	C.O. 3	MONTEDORO		27,84	
0,700	0,250		11		8,580
1,400	0,700		12		7,880
2,200	0,800		13		7,080
4,900	2,700		14		4,380
7,800	2,900		15		1,480

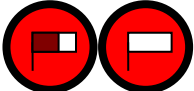
SETTORE					9,280
2	C.O. 2	FORINO - STADIO			0.20
	C.O. 3	MONTEDORO			27,84
8,400	0,600		16		0,880
9,200	0,800		17	0,800	0,080
9,250	0,050		18		0,030
9,280	0,030		19	 C.O 3	0,000

SETTORE					10,570
3	C.O. 3	MONTEDORO			0.25
	C.O. 4	FORINO - STADIO			25,37
0,000	-		1	 C.O 3	10,570
0,020	0,020		2	 Start P.C. 22	10,550
0,060	0,040		3	 Fine P.C. 23 - Start P.C.23	10,510
0,110	0,050		4	 Fine P.C. 23 - Start P.C. 24	10,460
0,150	0,040		5	  PROSSIMA NOTA A MENO DI 200 MT Fine P.C. 24 - Start P.C.25	10,420

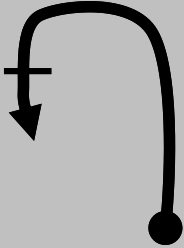
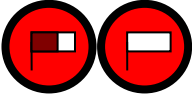
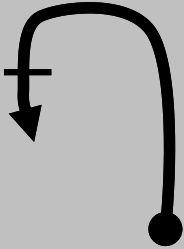
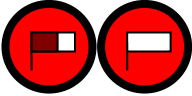

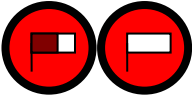
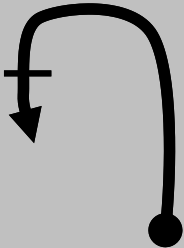
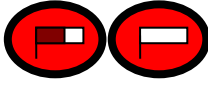
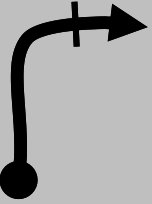
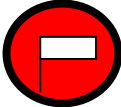

SETTORE			10,570		
3	C.O. 3	MONTEDORO		0,25	
	C.O. 4	FORINO - STADIO		25,37	
0,200	0,050		6	 Fine P.C. 25 - Start P.C. 26	10,370
0,240	0,040		7	 Fine P.C. 26 - Start P.C.27	10,330
0,290	0,050		8	 Fine P.C. 27 - Start P.C.28	10,280
0,330	0,040		9	 Fine P.C. 28	10,240
0,430	0,100		10		10,140

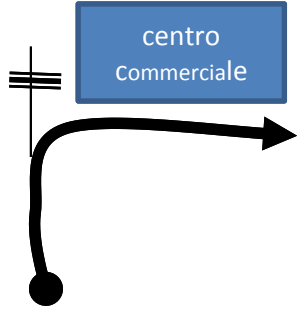
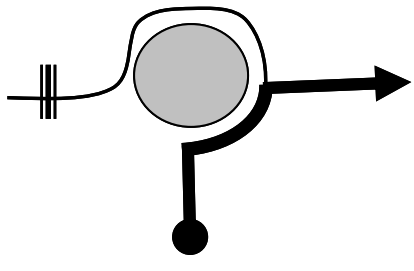
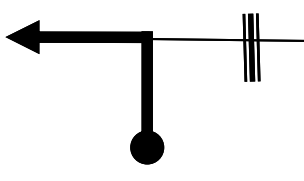
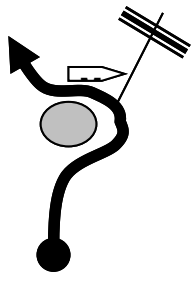
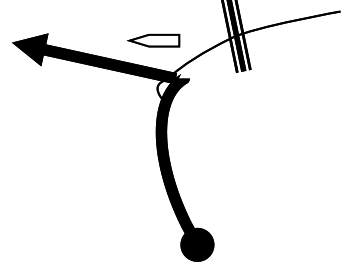

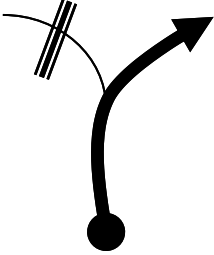
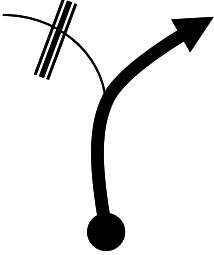
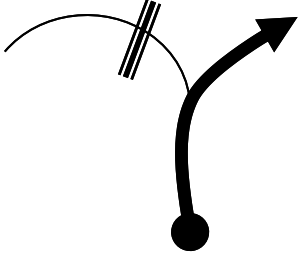
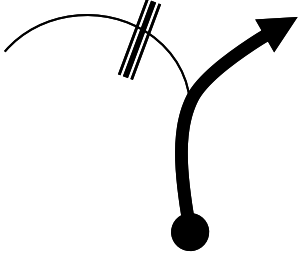
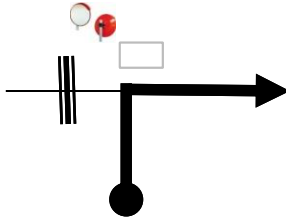
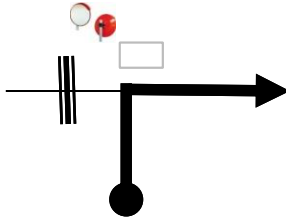
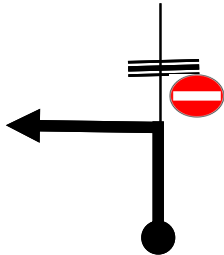
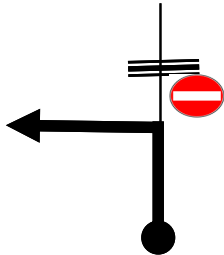

SETTORE			10,570				
3	C.O. 3	MONTEDORO		0,25			
	C.O. 4	FORINO - STADIO		25,37			
0,680	0,250		<div style="border: 1px solid black; padding: 5px; margin-bottom: 5px;">centro commerciale montedoro</div> <div style="border: 1px solid black; padding: 5px;">!!! procedere a passo d'uomo !!! possibile incrocio con altri concorrenti</div>	11	9,890		
0,730	0,050			12	9,840		
0,750	0,020			13	Start P.C. 29	9,820	
0,780	0,030				14	Fine P.C. 29 Start P.C. 30	9,790
0,810	0,030				15	 PROSSIMA NOTA A MENO DI 200 MT <b>FINE PC 30 START PC 31</b>	9,760

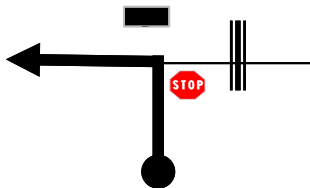
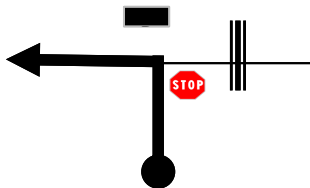

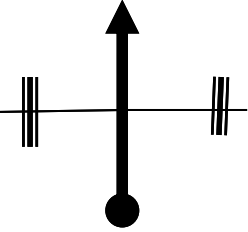
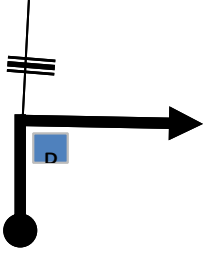

SETTORE			10,570		
3	C.O. 3	MONTEDORO		0.25	
	C.O. 4	FORINO - STADIO		25,37	
0,860	0,050		16	 <b>FINE PC 31 START PC 32</b>	9,710
0,910	0,050		17	 <b>FINE PC 32 START PC 33</b>	9,660
0,940	0,030		18	 <b>FINE PC 33 START PC 34</b>	9,630
0,990	0,050		19	 <b>FINE PC 34 START PC 35</b>	9,580
1,020	0,030		20	  <b>PROSSIMA NOTA A MENO DI 200 MT</b> <b>FINE PC 35</b>	9,550

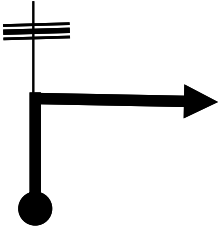
SETTORE			10,570		
3	C.O. 3	MONTEDORO		0.25	
	C.O. 4	FORINO - STADIO		25,37	
1,190	0,170		<p>!!! attenzione procedere a passo d'uomo</p>	21	9,380
1,260	0,070		<p>!!! procedere a passo d'uomo siete nel parcheggio di un centro commerciale</p>	22	9,310
1,290	0,030		IMMISSIONE SU STRADA STATALE	23	9,280
2,040	0,750		<p><del>MONTEFORTE I.</del></p>	24	8,530
2,640	0,600		<p>autocarrozzeria</p>	25	7,930

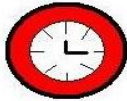

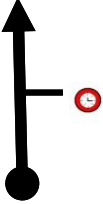
SETTORE			10,570		
3	C.O. 3	MONTEDORO	0.25		
	C.O. 4	FORINO - STADIO	25,37		
5,540	2,900		26		5,030
8,240	2,700		27	 <p>FORINO</p> <p>AVELLINO</p>	2,330
9,040	0,800		28	<p>CARABINIERI</p> 	1,530
9,190	0,150		29	 <p>A 120 mt</p> <p>via Don Minzoni</p> 	1,380
9,590	0,400		30	<p>Piazza Tigli</p>  <p>STOP</p>  <p>PROSSIMA NOTA A MENO DI 200 MT</p>	0,980

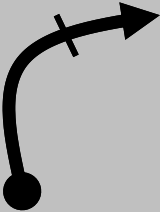
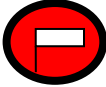
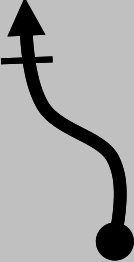
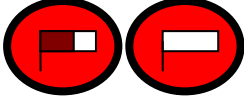
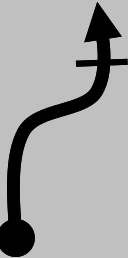
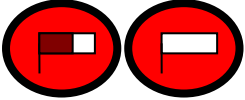
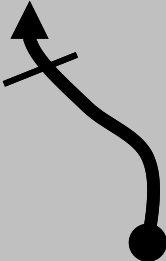
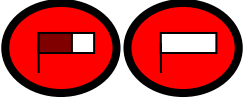

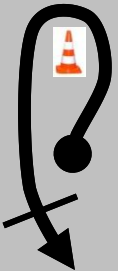
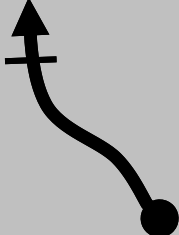
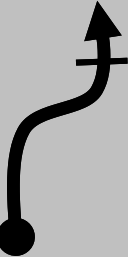
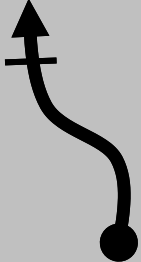
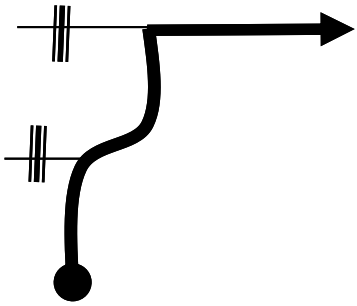

SETTORE			10,570		
3	C.O. 3	MONTEDORO			
	C.O. 4	FORINO - STADIO			
9,640	0,050		31	Caffetteria - Gelateria	0,930
9,690	0,050		32		0,880
10,490	0,800		33		0,080
10,540	0,050		34		0,030
10,570	0,030		35	 C.O 4	0,000

SETTORE			10,540		
4	C.O. 4	FORINO - STADIO	0.25		
	C.O. 5	MONTE DORO - FINE GARA	25,30		
0,000	-		1	 C.O. 4	10,540
0,050	0,050		2	 Start P.C. 36	10,490
0,100	0,050		3	 Fine P.C. 36 Start P.C. 37	10,440
0,140	0,040		4	 Fine P.C. 37 Start P.C. 38	10,400
0,175	0,035		5	  PROSSIMA NOTA A MENO DI 200 MT Fine P.C. 38 - Start P.C. 39	10,365

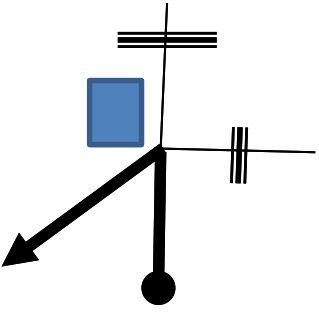

IN MANCANZA DI INDICAZIONI PROSEGUIRE DRITTO

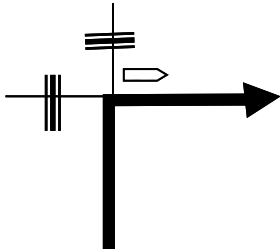
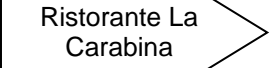
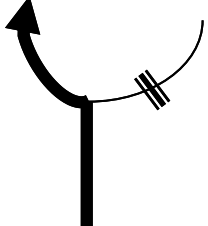
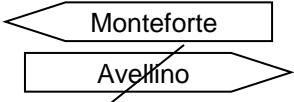
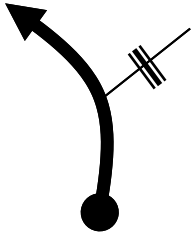
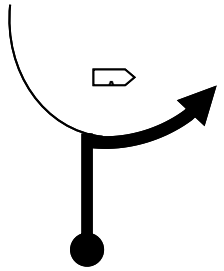
SETTORE			10,540
4	C.O. 4	FORINO - STADIO	0.25
	C.O. 5	MONTEORO - FINE GARA	25,30
0,225	0,050		6 Fine P.C. 39 - Start P.C.40 10,315
0,260	0,035		7 Fine P.C. 40 - Start P.C.41 10,280
0,300	0,040		8 Fine P.C. 41 - Start P.C.42 10,240
0,350	0,050		9 Fine P.C. 42 10,190
0,450	0,100		10 !!! IMMISSIONE SU S.P. 10,090



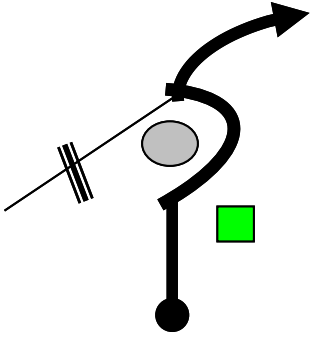
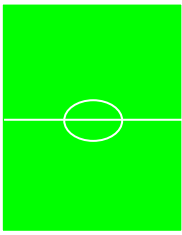
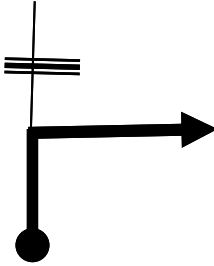
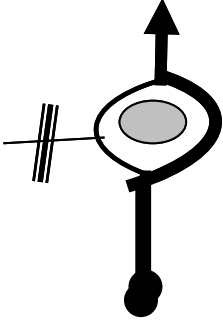
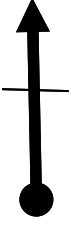
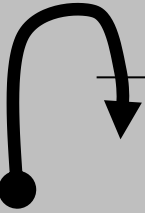
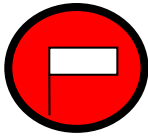

IN MANCANZA DI INDICAZIONI PROSEGUIRE DRITTO

SETTORE			10,540		
4	C.O. 4	FORINO - STADIO	0.25		
	C.O. 5	MONTEORO - FINE GARA	25,30		
0,700	0,250		11		9,840
1,400	0,700		12		9,140
2,200	0,800		13		8,340
4,900	2,700		14		5,640
7,800	2,900		15		2,740



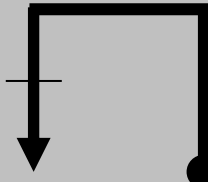

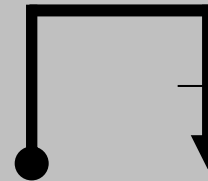
IN MANCANZA DI INDICAZIONI PROSEGUIRE DRITTO

SETTORE			10,540		
4	C.O. 4	FORINO - STADIO	0.25		
	C.O. 5	MONTEORO - FINE GARA	25,30		
8,400	0,600		16		2,140
9,200	0,800		17	0,800	1,340
9,250	0,050		18		1,290
9,280	0,030		19		1,260
9,300	0,020		20	  <b>PROSSIMA NOTA A MENO DI 200 MT</b> <b>Start P.C. 43</b>	1,240

IN MANCANZA DI INDICAZIONI PROSEGUIRE DRITTO

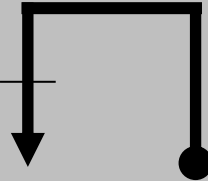
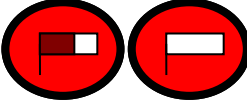
SETTORE			10,540
4	C.O. 4	FORINO - STADIO	0.25
	C.O. 5	MONTEORO - FINE GARA	25,30
9,340	0,040		21 Fine P.C. 43 - Start P.C.44 1,200
9,390	0,050		22 Fine P.C. 44- Start P.C.45 1,150
9,430	0,040		23 Fine P.C. 45 - Start P.C.46 1,110
9,480	0,050		24 Fine P.C. 46 - Start P.C. 47 1,060
9,520	0,040		25  PROSSIMA NOTA A MENO DI 200 MT Fine P.C. 47 - Start P.C.48 1,020

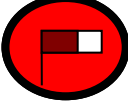
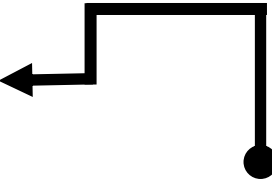
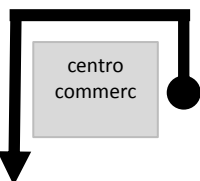
IN MANCANZA DI INDICAZIONI PROSEGUIRE DRITTO

SETTORE			10,540		
4	C.O. 4	FORINO - STADIO	0.25		
	C.O. 5	MONTEORO - FINE GARA	25,30		
9,570	0,050		26	 <p>Fine P.C. 48 - Start P.C.49</p>	0,970
9,610	0,040			27	 <p>Fine P.C.49</p>
9,710	0,100		28		0,830
9,960	0,250		29	<div style="border: 1px solid gray; padding: 5px; width: fit-content; margin: 0 auto;"> <p>centro commerciale montedoro</p> </div> <div style="border: 1px solid gray; padding: 5px; width: fit-content; margin: 5px auto;"> <p>!!! procedere a passo d'uomo !!! possibile incrocio con altri concorrenti</p> </div>	0,580
10,010	0,050			30	 <p>PROSSIMA NOTA A MENO DI 200 MT</p>

IN MANCANZA DI INDICAZIONI PROSEGUIRE DRITTO



SETTORE			10,540		
4	C.O. 4	FORINO - STADIO	0.25		
	C.O. 5	MONTEORO - FINE GARA	25,30		
10,030	0,020		31	 Start P.C. 50	0,510
10,060	0,030		32	 Fine P.C. 50 Start P.C. 51	0,480
10,090	0,030		33	 Fine P.C. 51 - Start P.C. 52	0,450
10,140	0,050		34	 Fine P.C. 52 Start P.C. 53	0,400
10,190	0,050		35	  PROSSIMA NOTA A MENO DI 200 MT Fine P.C. 53 - Start P.C. 54	0,350

IN MANCANZA DI INDICAZIONI PROSEGUIRE DRITTO

SETTORE				10,540	
4	C.O. 4	FORINO - STADIO		0.25	
	C.O. 5	MONTEDORO - FINE GARA		25,30	
10,220	0,030		36	 Fine P.C. 54 - Start P.C. 55	0,320
10,270	0,050		37	 Fine P.C. 55 - Start P.C. 56	0,270
10,300	0,030		38	 Fine P.C. 56	0,240
10,470	0,170		39	!!! attenzione procedere a passo d'uomo	0,070
10,540	0,070		40	 !!! procedere a passo d'uomo C.O. 5	0,000

IN MANCANZA DI INDICAZIONI PROSEGUIRE DRITTO